

Master Surface Design with SolidWorks 2024: A Comprehensive Guide for Beginners and Intermediate Users

Are you ready to take your surface design skills to the next level with SolidWorks 2024? Our comprehensive guide is meticulously crafted to empower both beginners and intermediate users with the knowledge and techniques to create exceptional 3D models.

Chapter 1: Getting Started with SolidWorks Surface Design

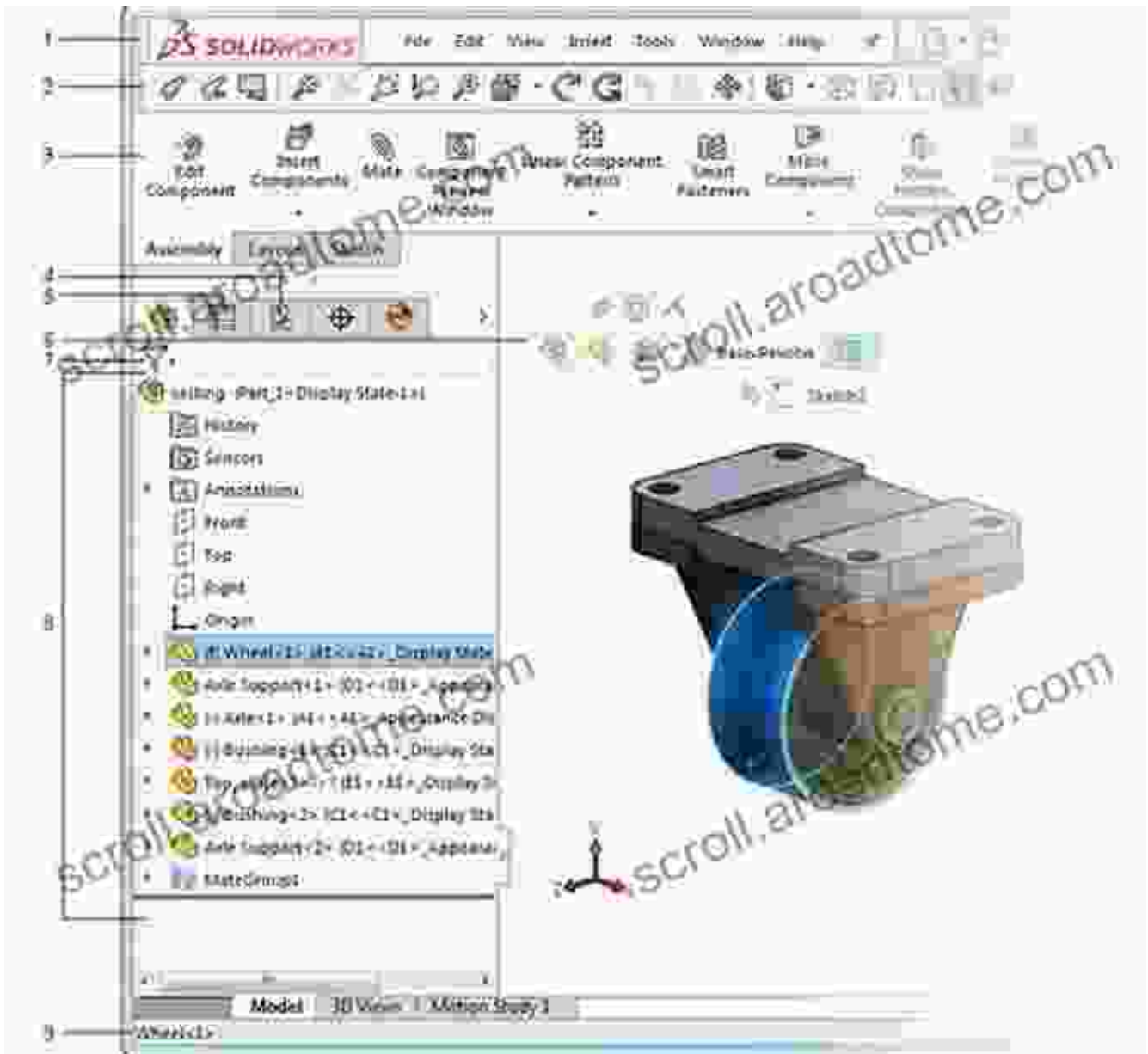

SOLIDWORKS Surface Design 2024 for Beginners and Intermediate Users by CADArtifex

★★★★★ 5 out of 5

- Language : English
- File size : 13175 KB
- Text-to-Speech : Enabled
- Screen Reader : Supported
- Enhanced typesetting : Enabled
- Print length : 130 pages
- Lending : Enabled

FREE

DOWNLOAD E-BOOK



Embark on your SolidWorks Surface Design journey with a thorough to the user interface, essential tools, and workflow. Learn how to navigate the software, customize your workspace, and understand the fundamentals of surface modeling.

Chapter 2: Mastering Basic Surface Creation Techniques

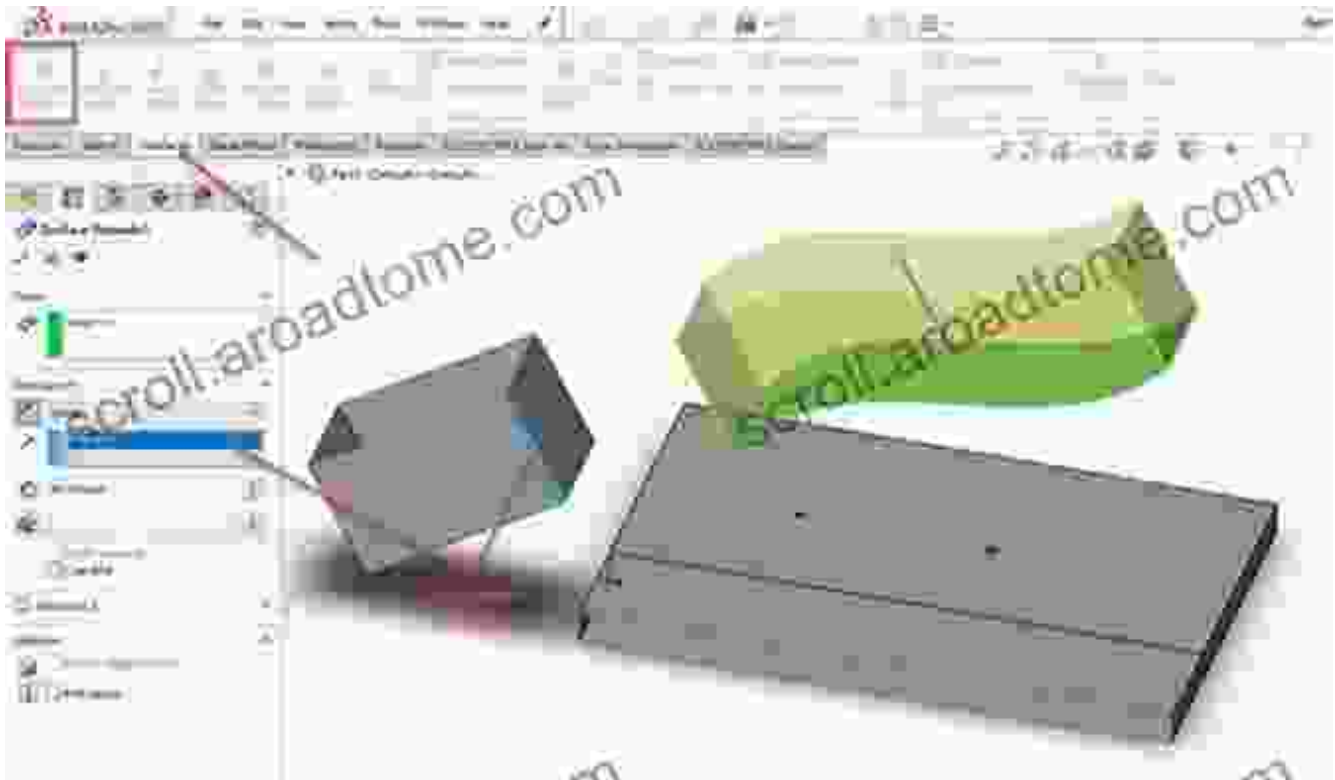

Delve into the world of surface creation by mastering extrusion, revolve, loft, and sweep techniques. Discover how to manipulate sketched profiles and generate complex surfaces with precision.

Chapter 3: Advanced Surface Editing and Manipulation

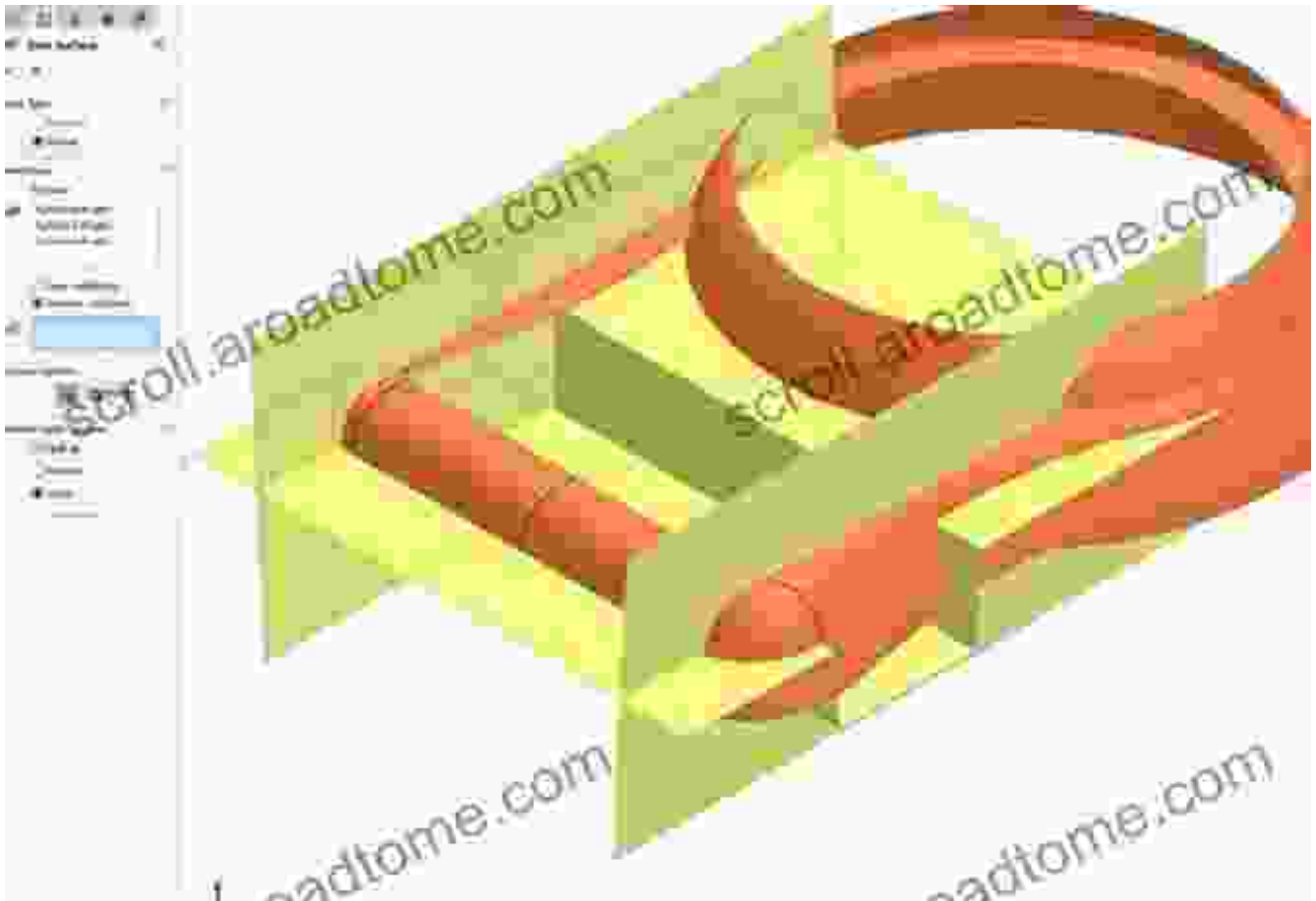

Elevate your surface design skills by exploring advanced editing tools such as trim, extend, split, and merge. Learn how to modify and refine surfaces to meet your design requirements.

Chapter 4: Creating Complex Surfaces with Feature-Based Modeling

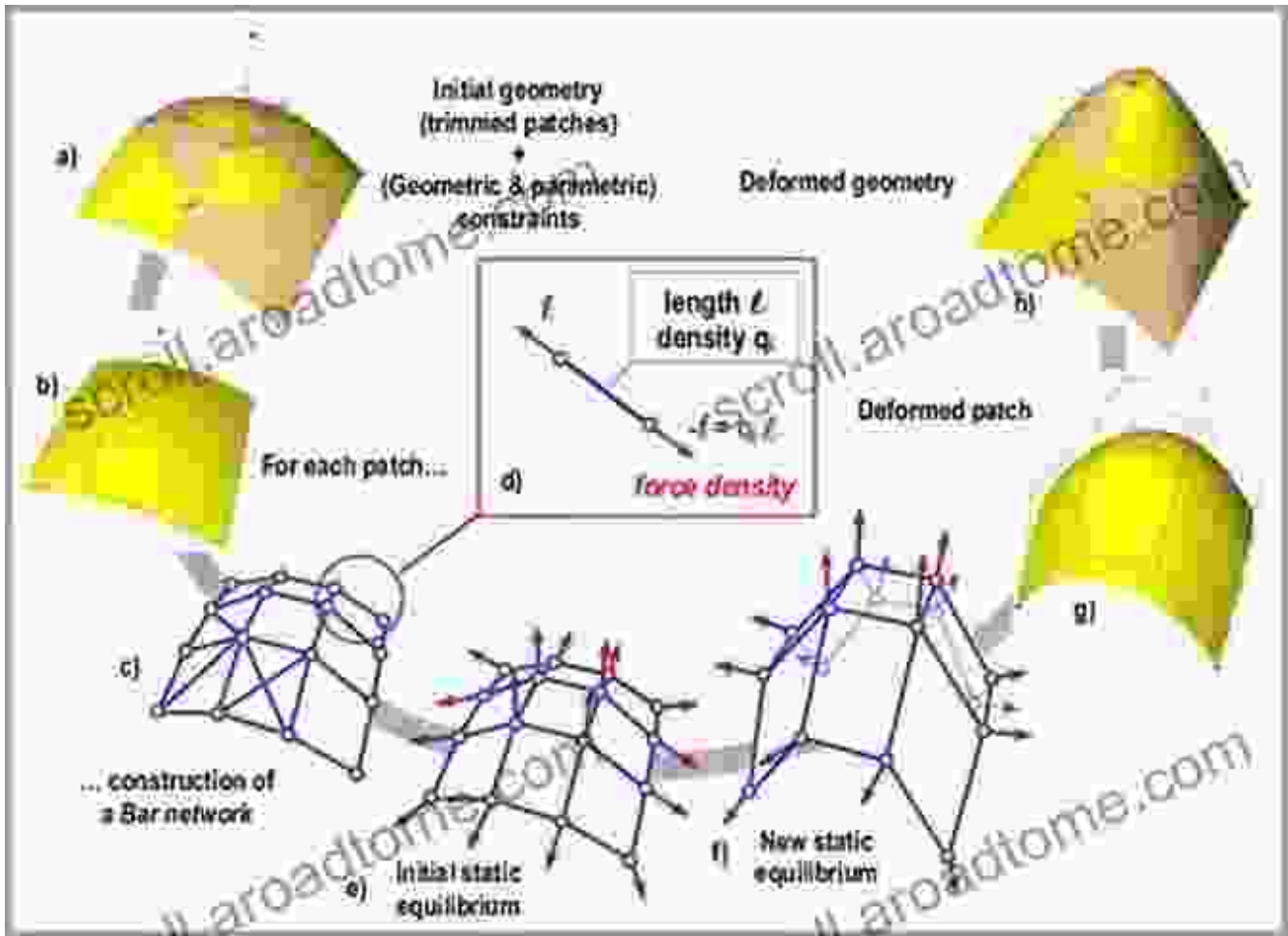

Push the boundaries of surface design by exploring advanced techniques such as free-form modeling, curvature continuity, and surface blending. Learn how to create organic and aesthetically pleasing shapes with ease.

Chapter 6: Surface Analysis and Evaluation

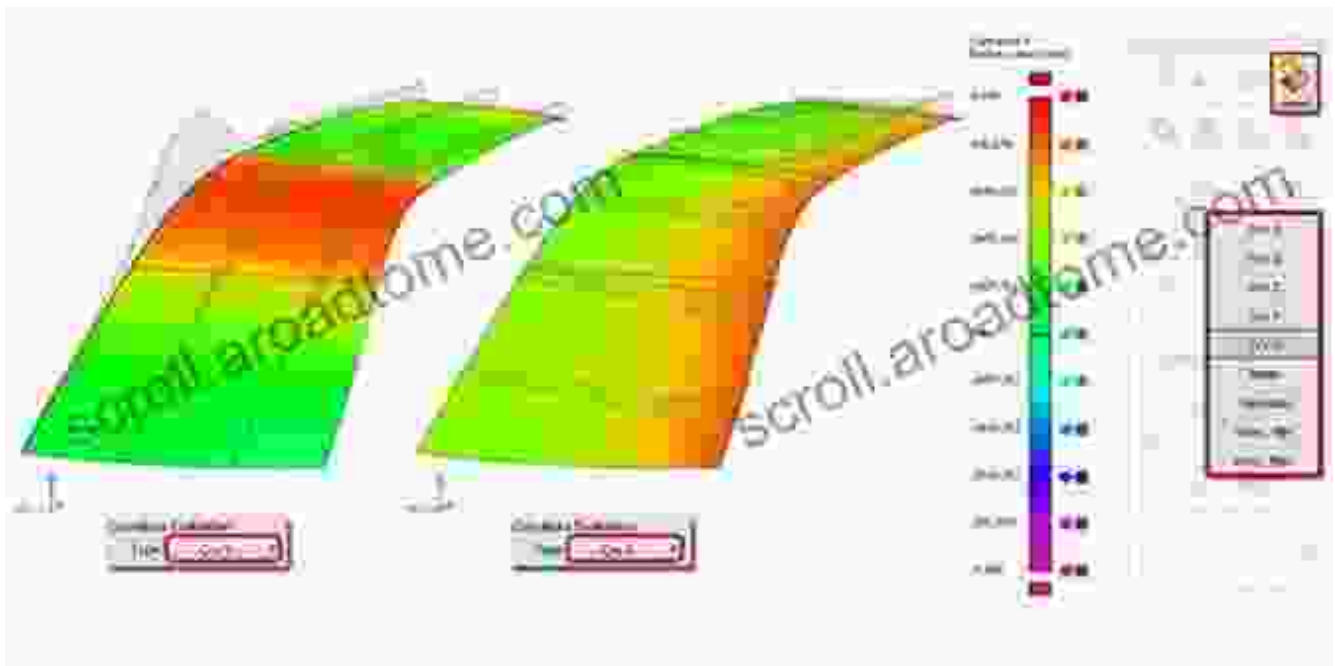

Ensure the integrity of your surfaces by performing thorough analysis. Discover how to measure curvature, thickness, and other critical parameters to optimize your designs.

Chapter 7: Applying Textures and Decals

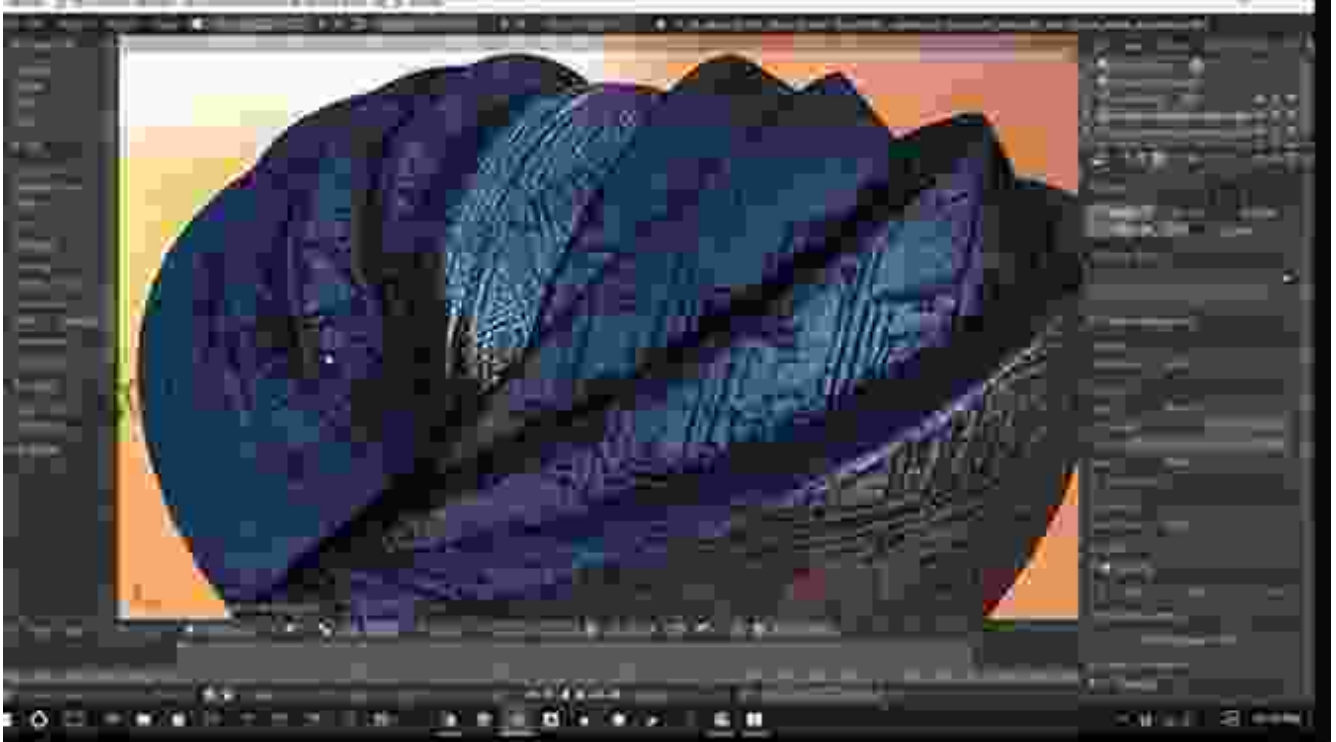

Bring your designs to life by applying realistic textures and decals. Learn how to enhance the visual appeal of your models and create photorealistic renderings.

Chapter 8: Integrating Surface Design with Assemblies and Drawings

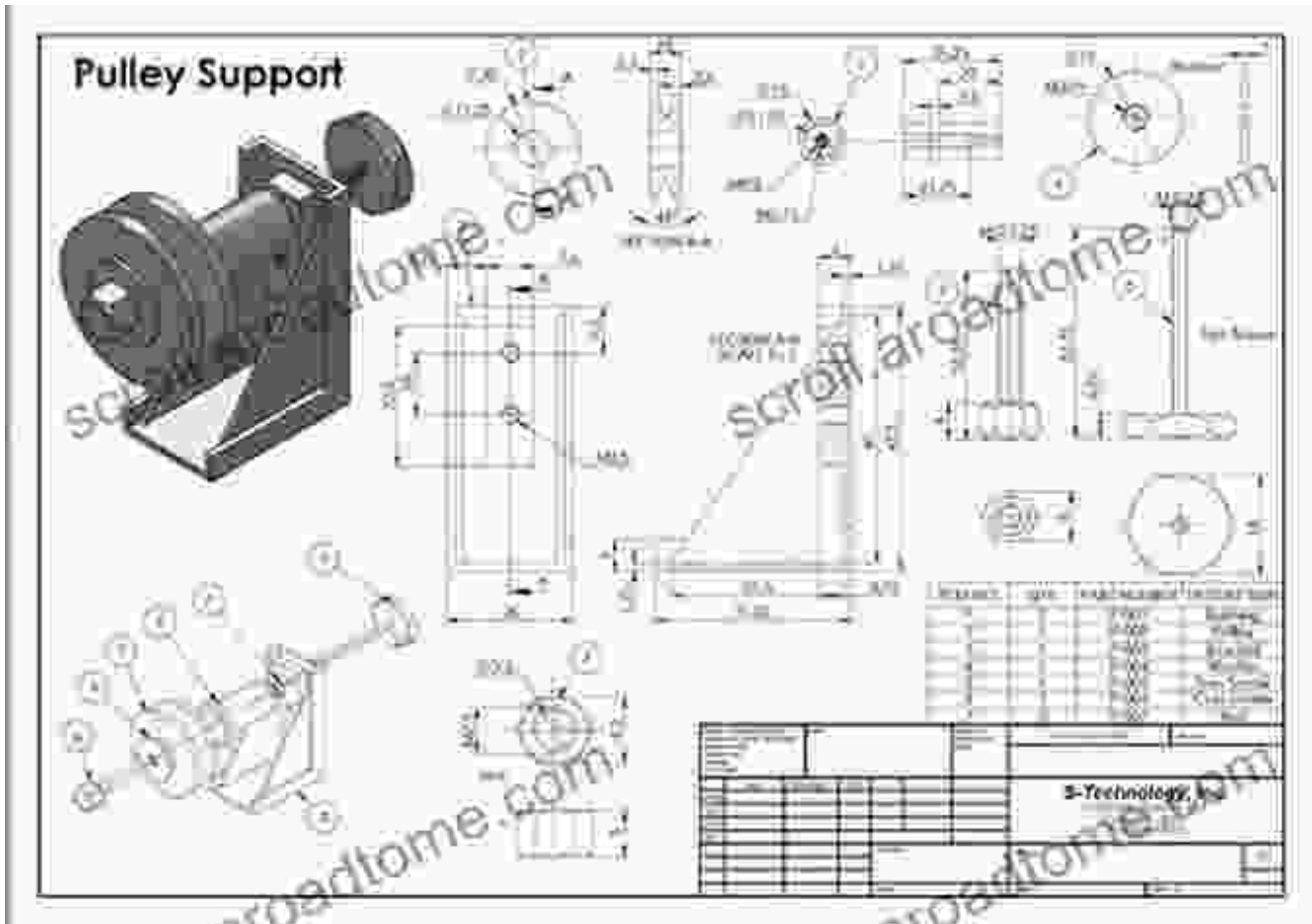

Seamlessly integrate your surface designs into larger assemblies and drawings. Discover the best practices for managing surface data, creating section views, and generating detailed documentation.

Chapter 9: Real-World Applications and Case Studies



Gain practical insights through real-world case studies. Explore how surface design is applied in industries such as automotive, aerospace, consumer products, and medical devices.

Chapter 10: Advanced Topics and Best Practices

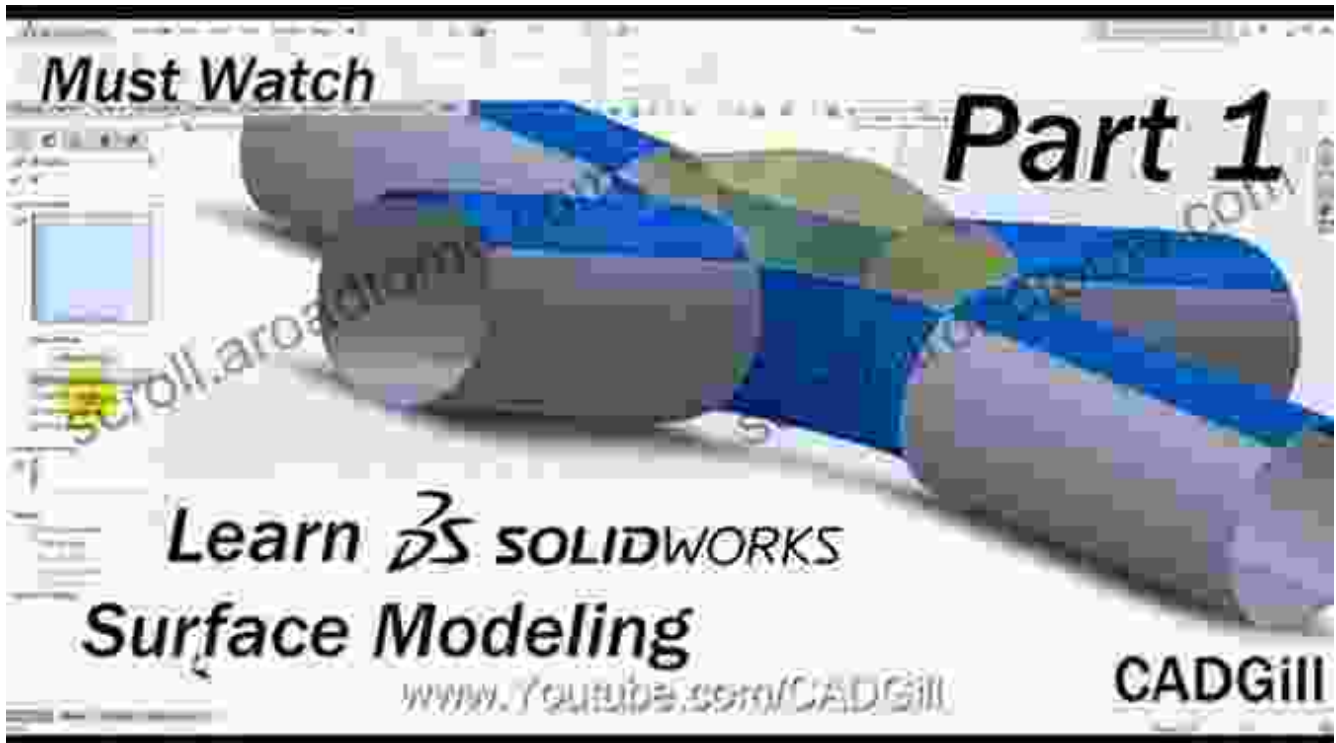

Maximize your surface design efficiency by uncovering advanced topics and best practices. Learn about surfacing workflows, optimization techniques, and tips to enhance your productivity.

Whether you're a beginner looking to master the basics or an intermediate user seeking to expand your skills, this comprehensive guide will empower you to create exceptional 3D models with SolidWorks Surface Design 2024. Embrace the freedom of surface modeling and unlock your design potential today!

Bonus Content

- Interactive exercises and practice files
- Access to online tutorials and support forums
- Detailed glossary of surface design terminology

Free Download Your Copy Today!

Invest in your surface design journey and Free Download your copy of "SolidWorks Surface Design 2024 For Beginners And Intermediate Users" today. Elevate your skills, create stunning 3D models, and revolutionize your design process.



SOLIDWORKS Surface Design 2024 for Beginners and Intermediate Users by CADArtifex

★★★★★ 5 out of 5

Language : English
File size : 13175 KB
Text-to-Speech : Enabled
Screen Reader : Supported
Enhanced typesetting : Enabled
Print length : 130 pages
Lending : Enabled

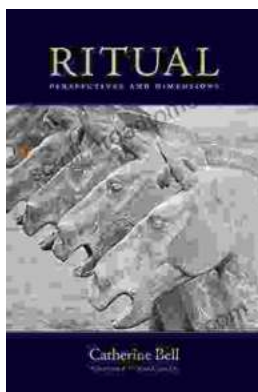

Embark on a Transformative Journey: Discover Ritual Perspectives and Dimensions by Catherine Bell

Delve into the Enigmatic World of Rituals Step into the captivating realm of rituals, where symbolic actions, beliefs, and social norms intertwine to shape human...



Unleash Your Soul: A Journey to Less Noise, More Soul

Embrace the Power of Silence in a Noisy World In the relentless cacophony of modern life, it's easy to lose touch with our true selves. External stimuli...